

The Possible ‘Impossible’ Turn

David F. Rogers[†]

United States Naval Academy
Annapolis, Maryland 21402
dfr@nar-associates.com

Copyright ©1994 David F. Rogers, All rights reserved.

Originally published in the AIAA Journal of Aircraft, Vol. 32, pp. 392-397, 1995 with permission.

Abstract

Turning back after engine failure during the take off phase of flight in a single engine aircraft is examined using a simplified analytical model. The important parameters are identified. The analysis shows that the optimum flight path is teardrop shaped with a 45° bank angle at stall velocity during the turn. The effects of engine failure altitude, wind direction and velocity, and bank angle on the required runway length are examined. The results show that the typical recommendations for general aviation single engine aircraft are not optimum.

Nomenclature

C_D	drag coefficient
C_{D_0}	zero lift drag coefficient
C_L	lift coefficient
d	propeller diameter
D	drag
F_c	centripetal force
g	acceleration of gravity
h	altitude
J	advance ratio
L	lift
L/D	lift to drag ratio
n	propeller rpm
R	turn radius
R/C	rate of climb
S	wing area
t	time
V	velocity
V_{cruise}	cruise velocity
$V_{L/D\text{max}}$	velocity for maximum L/D
$V_{R/C\text{max}}$	velocity for maximum rate of climb
$V_{\text{stall (clean)}}$	stall velocity gear and flaps up
$V_{\text{stall (dirty)}}$	stall velocity gear and flaps down
V_{turning}	velocity in a coordinated turn
$V_{\gamma\text{max}}$	velocity for maximum climb angle
W	weight
η	propeller efficiency
ϕ	bank angle
Ψ	turn angle or heading
$\dot{\Psi}$	turn rate
ρ	density

[†]Professor, Aerospace Engineering Department, Associate Fellow AIAA

Introduction

If the engine of a single engine aircraft quits during the initial climb segment immediately after takeoff, conventional wisdom, and the FAA recommended procedure, is for the pilot to land straight ahead. Furthermore, conventional wisdom and the FAA recommendation say that under no circumstance should the pilot attempt to turn back and land on the departure runway. Certainly this is true if the engine quits at 10 or 50 or 100 or 200 feet. But what if the failure altitude is 300–1000 feet? Can a turn back to the departure or an intersecting runway be successfully completed? What is the proper procedure for the turn and subsequent power-off glide to a landing? What are the principal variables in the problem?

This problem is of particular interest to general aviation pilots of single engine aircraft. It is becoming of increasing interest to corporate and commercial operators, with the increase in the number of single engine high performance turboprop aircraft available for these operations. Unfortunately, the literature that exists, generally in the ‘popular’ aviation press, makes recommendations that are demonstrably incorrect. A good example is the article by John Eckalbar in the Newsletter of the American Bonanza Society¹ and his discussion of this maneuver in Ref. 2.

Using a Beech A36 Bonanza as an example and assuming no wind, Eckalbar¹ recommends initially climbing at the velocity for maximum rate of climb to a minimum of 1000 feet agl (above ground level) along the runway center line extended where engine failure is assumed to occur. A 270° unpowered gliding turn followed by an additional 90° unpowered gliding turn in the opposite direction to realign the aircraft with the runway is then performed. A velocity of $1.3V_{\text{stall (clean)}} / \cos \phi$ with a 35° bank angle is recommended for the turn. Upon completion of the turn the aircraft is accelerated to the velocity for L/D_{max} and continues to a landing. All transitions are assumed to occur instantaneously. Each of these recommendations, taken individually, is non-optimum. Collectively they result in failure of the aircraft to successfully complete the maneuver whenever the departure runway is less than 6000+ feet long. Because most aircraft of this type operate out of airports with runways considerably less than 6000 feet in length (typically 3000 feet in length), the maneuver recommended by Eckalbar will most likely result in an off airport landing.

As the analysis below shows, the velocity for maximum climb angle is a better choice for the initial climb segment, the minimum altitude above ground level is considerably less than 1000 feet agl, a teardrop flight path as shown in Fig. (1) with a turn of approximately 210° performed at $1.05V_{\text{stall (clean)}}$ at a 45° bank

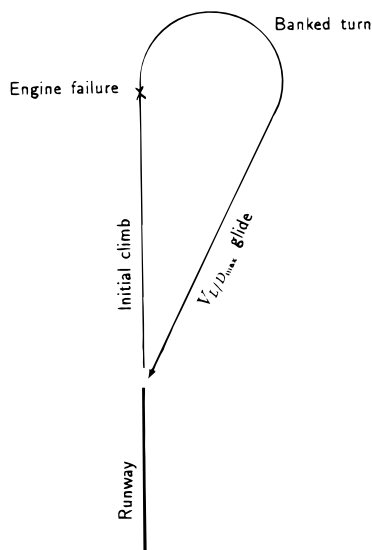

Figure 1. Teardrop flight path.

angle results in a more nearly optimum and more likely to succeed maneuver. Furthermore, the required runway length for successful completion is reduced by approximately a factor of eight.

The Optimum Bank Angle

Following the development in Jett³, we consider a simple energy analysis of the optimum conditions for a steady gliding turn to a new heading. In a gliding turn the aircraft trades the potential energy embodied in altitude to overcome drag and maintain velocity above the stall velocity of the aircraft. A larger bank angle in the gliding turn requires a higher rate of descent to maintain steady conditions. Consequently, minimum *time* in the gliding turn to a new heading yields the optimum turn conditions. From Fig. (2) we have

$$L \cos \phi = \frac{1}{2} \rho V^2 S C_L \cos \phi = W \quad (1)$$

and

$$F_c = L \sin \phi = \frac{V^2}{R} \frac{W}{g} \quad (2)$$

Thus, combining Eqs. (1) and (2) yields the radius of the turn, i.e.

$$R = \frac{V^2}{g \tan \phi} \quad (3)$$

Minimizing the radius of the turn keeps the aircraft close to the end of the runway and thus results in a decreased glide distance after completion of the turn.

The time required to turn thorough a given angle, Ψ , is

$$t = \frac{\Psi}{\dot{\Psi}} \quad (4)$$

and in a steady state turn

$$\dot{\Psi} = \frac{d\Psi}{dt} = \frac{V}{R} = \frac{\Psi}{t} \quad (5)$$

The rate at which the aircraft expends the potential energy available from altitude must equal the energy required to overcome drag. Thus,

$$W \frac{dh}{dt} = DV \quad (6)$$

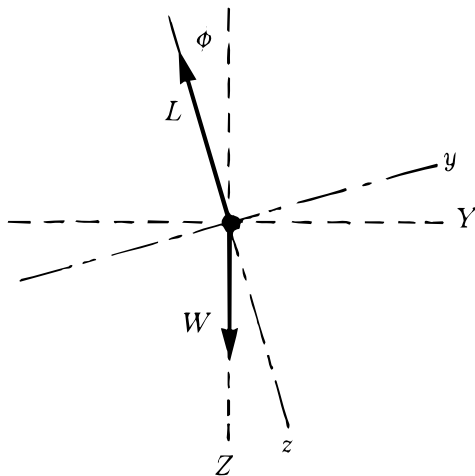

Figure 2. Forces in the yz plane acting on an aircraft in a steady state gliding turn.

Integrating for steady state conditions yields

$$W \frac{h}{t} = DV \quad (7)$$

or

$$h = \frac{DVt}{W} \quad (8)$$

Introducing Eqs. (3) and (5) yields

$$h = \frac{D}{W} V^2 \frac{\Psi}{g \tan \phi} \quad (9)$$

In a gliding turn with bank angle ϕ

$$\frac{D}{W} = \frac{C_D}{C_L \cos \phi} \quad (10)$$

Recalling that

$$V^2 = \frac{2W}{\rho S C_L \cos \phi} \quad (11)$$

Eq. (9) is written as

$$h = \frac{C_D}{C_L^2} \frac{4W}{\rho S g} \frac{1}{\cos \phi \sin \phi} \Psi \quad (12)$$

The steady state conditions for minimum loss of altitude in a gliding turn to a new heading are obtained by differentiating Eq. (12). The result is

$$\frac{dh}{d\Psi} = \frac{C_D}{C_L^2} \frac{4W}{\rho S g} \frac{1}{\sin 2\phi} \quad (13)$$

where we have used $\sin 2\phi = 2 \sin \phi \cos \phi$ to simplify the result.

Examining this result shows that for a parabolic drag polar, $C_D = C_{D_0} + kC_L^2$, the first term

$$\frac{C_D}{C_L^2} = \frac{C_{D_0}}{C_L^2} + k \quad (14)$$

is a minimum at $C_{L_{\max}}$. Thus, the optimum speed for minimum loss of altitude in a gliding turn to a new heading occurs for $C_{L_{\max}}$, i.e., at the stall velocity.

Neglecting the small density change with altitude, the second term, $4W/\rho S g \sin 2\phi$, is a minimum for $\sin 2\phi = 1$ or $\phi = 45^\circ$, i.e., the optimum bank angle during a gliding turn to a new heading is 45° .

The Simplified Model

A complex numerical integration of the aircraft equations of motion starting from initial brake release could be used to address the problem. However, a simplified ‘analytical’ model is adequate to illustrate the major aspects of the problem.

The simplified model uses data from the manufacturer’s pilot’s operating handbook (POH) for the subject aircraft to determine the initial take-off ground roll, rotation and lift-off velocities and the distance over a 50 foot obstacle. An instantaneous transition from the velocity at 50 feet to the specified climb out velocity is assumed. A steady climb at constant velocity from 50 feet to the failure altitude while maintaining runway heading is assumed. At engine failure an instantaneous transition to a banked descending gliding turn at the assumed bank angle and the assumed velocity is used. Upon completion of the turn an instantaneous transition to the velocity for L/D_{\max} is assumed. A glide at $V_{L/D_{\max}}$ until touch down is assumed. No allowance for the effects of landing gear retraction/extension are made.

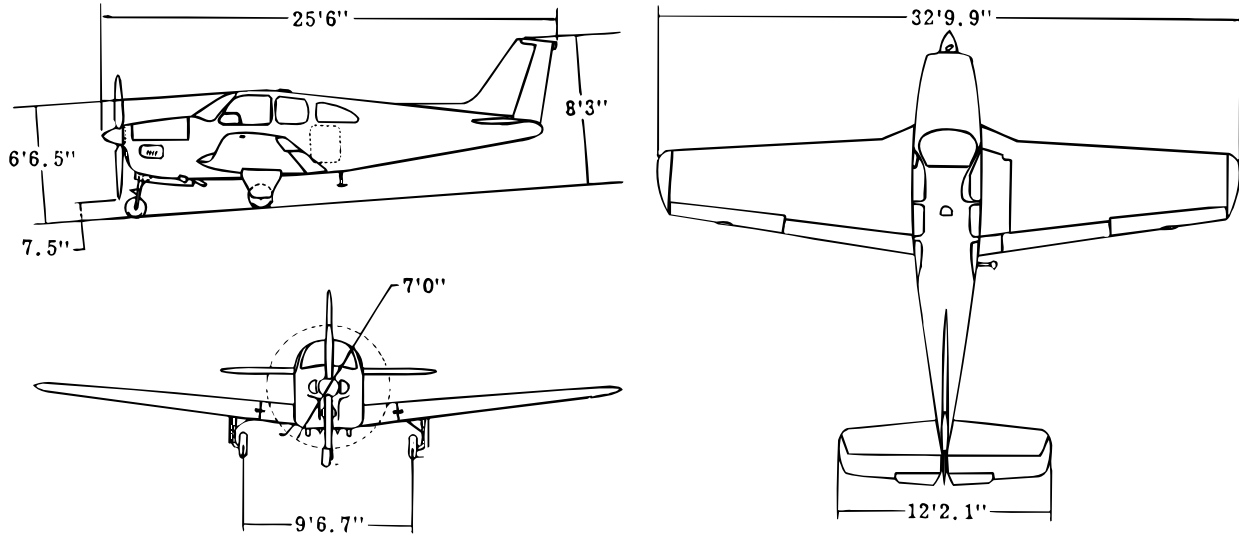

Figure 3. Model 33 Beech Bonanza

The Aircraft

The example aircraft chosen for study is a Model 33A 285 bhp single engine retractable Beech Bonanza. A three-view drawing is shown in Fig. (3). The aircraft characteristics are given in Table (1).

Table 1 Aircraft Characteristics
Beech Bonanza Model 33A

Gross weight	3300 lbs
Wing Area	181 ft ²
L/D_{\max}	10.56
Power	285 bhp
Propeller	Constant Speed 3-blade
V_{cruise} @ 65%	190 mph
V_{stall} (clean) Power off	72 mph
V_{stall} (dirty) Power off	61 mph
$V_{L/D_{\max}}$	122 mph
$V_{\gamma_{\max}}$ @ SL	91 mph
$V_{R/C_{\max}}$ @ SL	112.5 mph
R/C @ SL & 3300 lbs	1200 fpm

The drag polar for the aircraft is assumed parabolic, i.e.,

$$C_D = C_{D_0} + kC_L^2 \quad (15)$$

where C_{D_0} and k are determined on the basis of approximately 10 years of flight test results for this model aircraft. The aircraft is equipped with a constant-speed three blade propeller. The propeller efficiency, η , at full throttle and 2700 rpm at sea level is adequately represented by

$$\eta = 0.268587 + 1.233106 J - 0.6111475 J^2 \quad (16)$$

where $J = V/nd$ is the advance ratio with the velocity V in mph, n in revolutions per second, and the diameter, d , in feet.

At sea level at 3300 lbs gross weight the velocity for L/D_{\max} is 122 mph, the velocity for maximum rate of climb, $V_{R/C_{\max}}$, is 112.5 mph and the velocity for maximum climb angle, $V_{\gamma_{\max}}$, is 91 mph. The power-off stall velocity, $V_{\text{stall (clean)}}$, gear and flaps retracted is 72 mph.

The Results

The Foot Print Plot

Using the simplified model discussed above, the effect of climb velocity, bank angle, failure altitude, and head- and crosswind velocity were investigated. The landing footprint, defined as the possible landing area from a given altitude, is determined by climbing to the failure altitude, executing a turn at the specified bank angle through a specified heading change and then gliding at $V_{L/D_{\max}}$ until touchdown. Heading changes from 0–360° were considered. Figure 4 shows footprints for head winds of 0, 10, 20 and 30 mph, at bank angles of 35° and 45° for a climb velocity $V_{\gamma_{\max}} = 91$ mph and a failure altitude of 650' agl. The velocity in the turn is assumed to be $V_{\text{turning}} = 1.05V_{\text{stall (clean)}}/\cos\phi$ in the turn, i.e., the unbanked stall velocity divided by the $\cos\phi$ multiplied by 1.05.

The intersection of the footprint curve at the top of the graph represents the touchdown distance from brake release if the aircraft glides straight ahead after engine failure. The second (numerically smallest) intersection of the footprint curve with the ordinate represents the length of runway required for the aircraft to touch down on the departure end of the runway. The heading change is approximately 190–220°. Here the flight path is teardrop shaped, as shown in Fig. (1). The third intersection of the curve with the ordinate

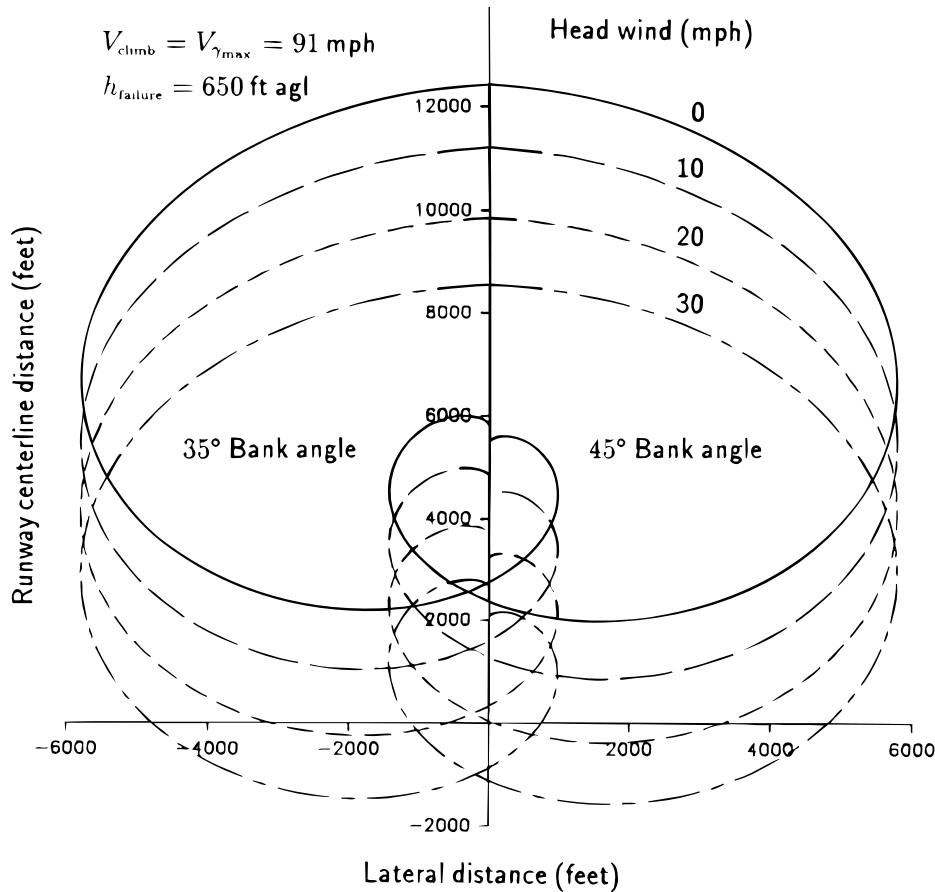

Figure 4. Foot print of possible landing sites after engine failure—no wind, climb velocity, $V_{\gamma_{\max}} = 91$ mph, failure altitude = 650 ft agl.

represents the length of runway required for the aircraft to turn through a full 360° and touch down on the runway. Notice that in each case the required runway length for the teardrop flight path is less for a 45° bank angle than for a 35° bank angle. Also notice that, as expected, an increase in the head wind velocity component results in a decrease in required runway length. Furthermore, for sufficiently large head wind velocities touchdown occurs beyond the take-off end of the runway.

Figures 5 and 6 illustrate the effect of wind on the footprint. In Fig. (5) the wind is 45° from the runway heading, with velocities of 0, 10, 20 and 30 mph. The aircraft is turned into the wind using a 45° bank angle. As expected, the crosswind component pushes the footprint downwind. For this specific case the runway length required for touch down on the departure end of the runway is increased by the decrease in the head wind velocity component and decreased by the slight reduction in required heading change. The net result is an increase in the required runway length. Notice that in all cases the crosswind velocity component, combined with a full 360° heading change, results in the aircraft being blown beyond the runway centerline.

In Fig. (6) the aircraft is turned downwind, i.e., away from the crosswind component. Again, the runway length required for touch down on the departure end of the runway is increased by the decrease in the head wind velocity component. However, and more importantly, the aircraft is now gliding into a head wind *after* completing the teardrop turn. The result is a significant *increase* in the required runway length for touch down on the departure end of the runway. In fact, for the 30 mph wind the aircraft cannot glide to the runway.

Effect of Climb Velocity, Failure Altitude and Bank Angle

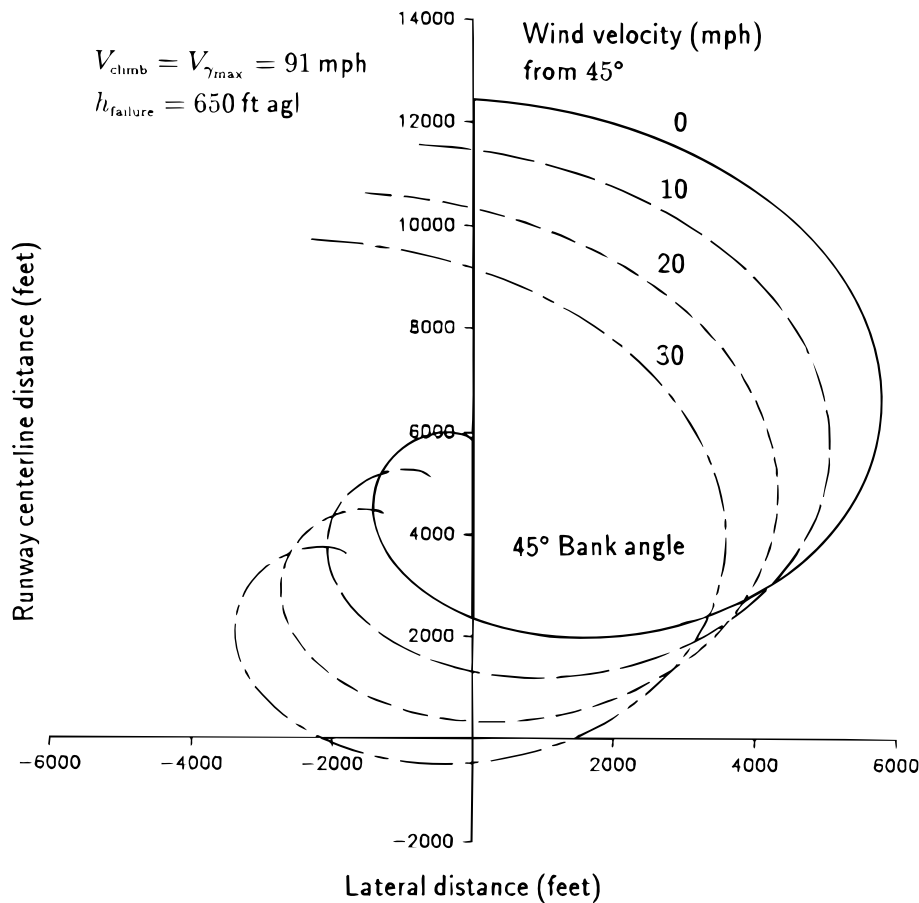

Figure 5. Footprint of possible landing sites after engine failure—wind from 45°, aircraft turned *into* the wind, climb velocity, $V_{\gamma_{max}} = 91 \text{ mph}$, failure altitude = 650 ft agl.

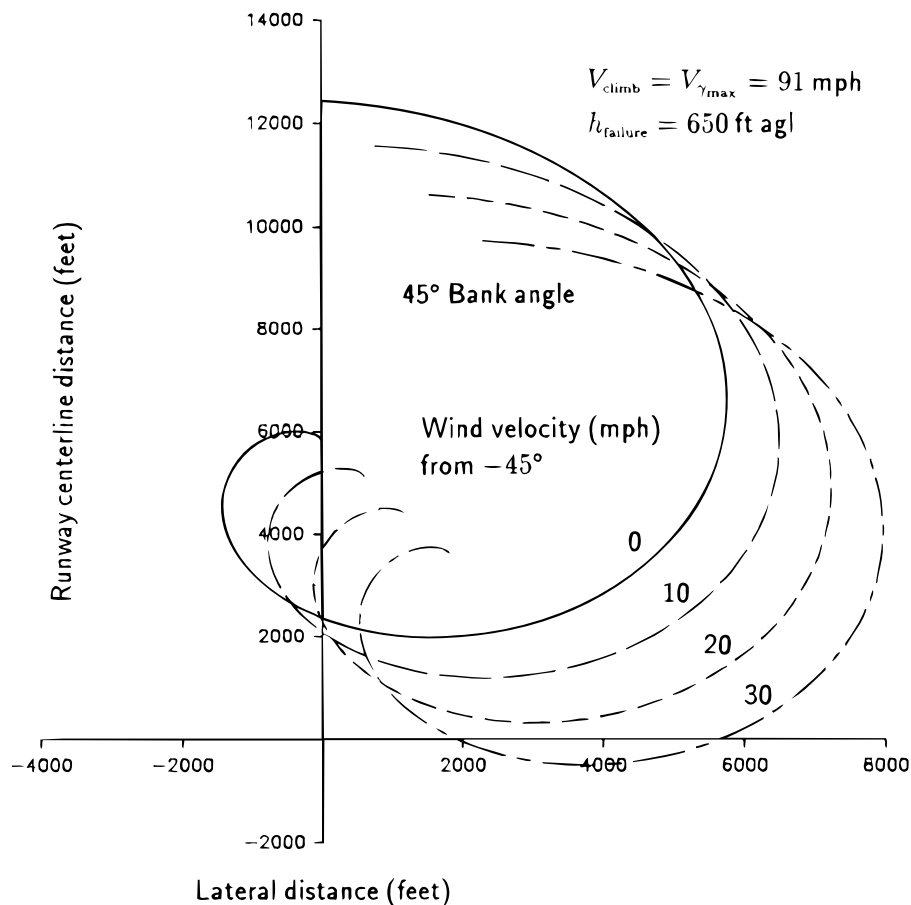

Figure 6. Footprint of possible landing sites after engine failure—wind from -45° , aircraft turned *away* from the wind, climb velocity, $V_{\gamma_{\max}} = 91$ mph, failure altitude = 650 ft agl.

For a given failure altitude two important parameters are, how close the aircraft is to the end of the departure runway and the length of the departure runway. Frequently the velocity for maximum rate of climb and a bank angle less than 45° is recommended for the initial climb out and turning phases. Figure 7 clearly shows that neither of these recommendations is optimum for successful completion of a turnback maneuver. Figure 7 shows the required runway length as a function of failure altitude for 35° and 45° bank angles and for climb out at the velocity for maximum rate of climb and maximum climb angle. The velocity in the turn is 5% above the stall velocity in the turn, i.e., $V_{\text{turning}} = 1.05V_{\text{stall (clean)}}/\cos\phi$. No wind and a teardrop flight path are assumed.

Figure 7 shows that climbing out at $V_{R/C_{\max}}$ vice $V_{\gamma_{\max}}$ for a failure altitude of 650 feet agl requires an additional 395 feet of runway when using either a 45° or 35° bank angle in the turn. Fundamentally the aircraft is closer to the airport when engine failure occurs when using $V_{\gamma_{\max}}$ vice $V_{R/C_{\max}}$ as a climb out velocity to a specific failure altitude.

Here it might be argued that time is a more appropriate variable for determining the engine failure point than altitude. Let us examine this question. It takes 3.5 sec longer to climb to 650 feet at $V_{\gamma_{\max}}$ than at $V_{R/C_{\max}}$. During that time the aircraft will increase its altitude by 77.4 feet. However, it will also be an additional 573 feet further down range. To this must be added the additional down range distance of 395 feet that results from using $V_{R/C_{\max}}$ vice $V_{\gamma_{\max}}$. The total additional distance down range using a climb out velocity of $V_{R/C_{\max}}$ is now 968 feet. At $V_{L/D_{\max}}$ the additional 77.4 feet of altitude results in an additional glide range of 817 feet, which results in an *increase* in the required runway length of 151 feet. Again, $V_{\gamma_{\max}}$ is a more optimum climb out velocity.

Examining Fig. (7), we further note that for the same failure altitude (650') climbing out at $V_{\gamma_{\max}}$ and

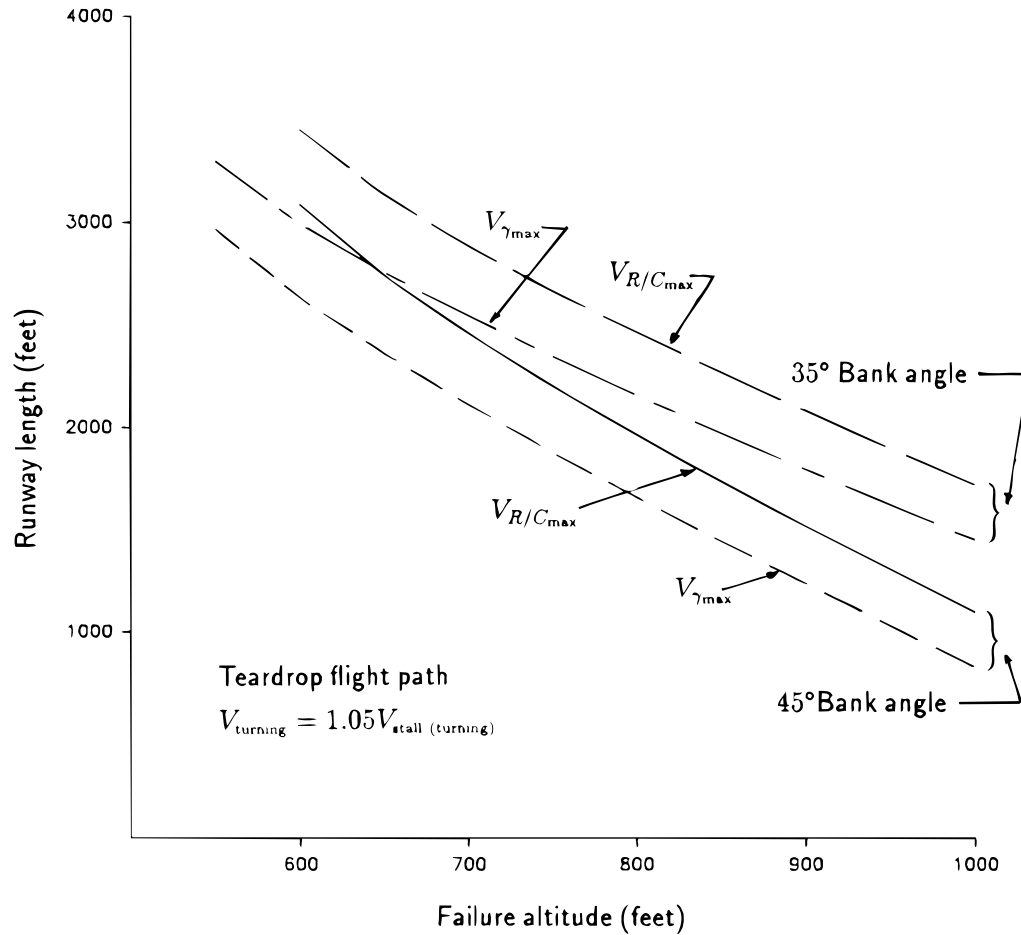

Figure 7. Effect of failure altitude on required runway length—no wind, turning velocity = $1.05V_{stall_{turning}}$, teardrop flight path.

using a 35° vice a 45° bank angle in the turn requires an additional 380 feet of runway. Fundamentally, the larger bank angle results in a smaller turn radius. Hence the aircraft is closer to the runway end at completion of the turn.

In both cases, using $V_{R/C_{max}}$ vice $V_{\gamma_{max}}$ for the climb out velocity and using 35° vice 45° for the bank angle in the turn results in a 10–15% increase in the runway length required for touch down on the departure runway.

Required Heading Angle Change

Figure 8 shows the heading change required to intercept the departure runway at the minimum required length as a function of bank angle. The climb out velocity is $V_{\gamma_{max}}$. The velocity in the turn is 5% above the stall velocity in the turn, i.e., $V_{turning} = 1.05V_{stall(clean)}/\sqrt{\cos\phi}$. No wind and a teardrop flight path are assumed. The heading change decreases with increasing failure altitude and ranges from approximately $190\text{--}220^\circ$. Note that this is considerably less than the 360° postulated by Eckalbar in Ref. 1.

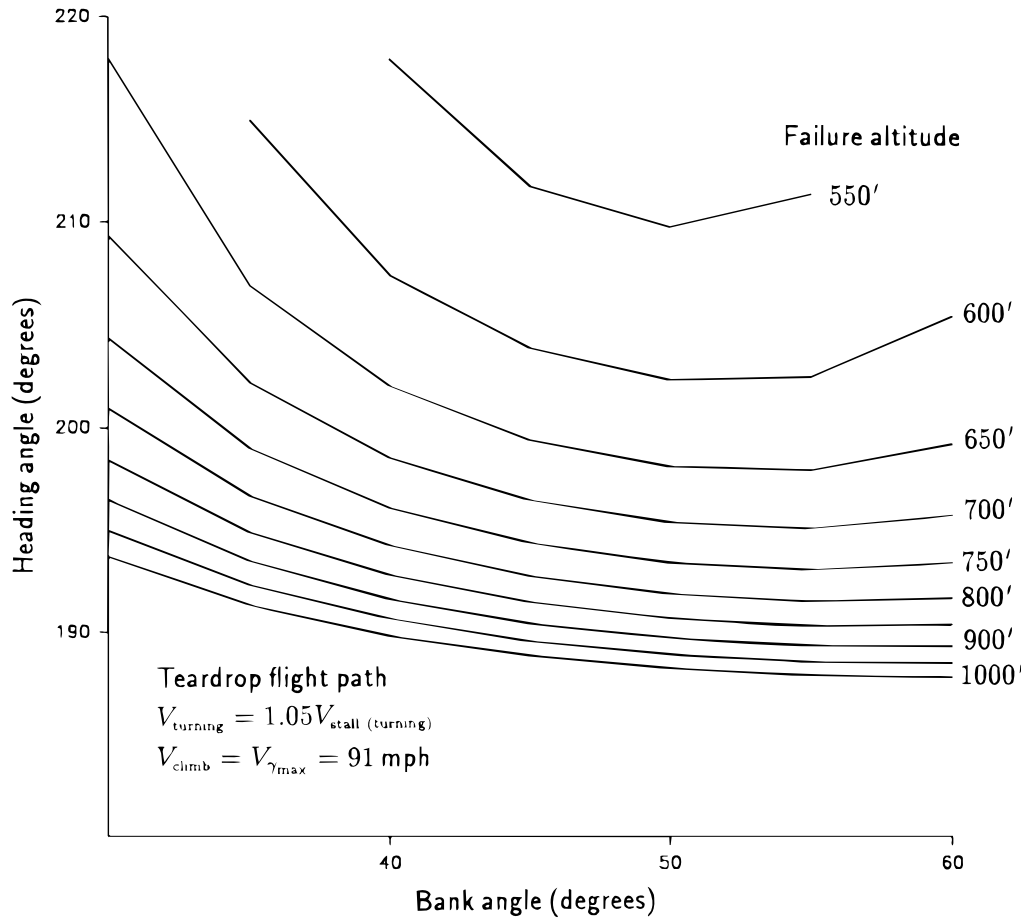

Figure 8. Total heading change for a teardrop flight path— no wind, turning velocity = $1.05V_{stall_{turning}}$, teardrop flight path, climbout velocity = $V_{\gamma_{max}} = 91$ mph.

The Validity of the Simplified Model

Let us briefly look at the effect of the assumptions used for the simplified model. The aircraft POH shows that for a normal gross weight take-off the lift-off speed is 80 mph and the speed at 50 feet is 90.5 mph. Notice that the speed at 50 feet is within $\frac{1}{2}$ mph of $V_{\gamma_{max}}$. Using the POH numbers for the take-off distance over a 50 foot obstacle makes this effect negligible when using $V_{\gamma_{max}}$ for the steady climb. When using $V_{R/C_{max}}$ for the steady climb it is necessary for the aircraft to accelerate from 90.5 mph to 112.5 mph, which requires approximately 7 seconds. The decrease in rate of climb is 58 fpm, which results in a decrease in altitude gained of 7 feet and a decreased down range distance of 113 feet. During the additional time required to reach the specified failure altitude the aircraft will travel an additional 52 feet down range. Thus, the aircraft is estimated to be approximately 61 feet closer to the runway at engine failure than indicated by the simplified model.

The Model 33 Beech Bonanza has a roll rate in excess of $45^\circ/\text{sec}$. Thus, approximately 1 sec is required to roll into a 45° bank. Using a stall safety factor of 1.05, the required velocity in the turn is 107.7 mph compared to $V_{\gamma_{max}} = 90.5$ mph and $V_{R/C_{max}} = 112.5$ mph. When climbing out at $V_{\gamma_{max}}$ a small loss in altitude will result when rolling into the turn, and decreasing attitude to prevent stalling while no or a slight altitude gain will result for a climb out velocity of $V_{R/C_{max}}$.

Again, approximately one second is required to roll out of the 45° banked turn, and approximately

7.7 seconds are required to accelerate the aircraft from 107.7 mph to $V_{L/D_{\max}} = 122$ mph. During the acceleration the aircraft travels approximately 80 feet less distance towards the runway than if it were flying at $V_{L/D_{\max}}$. However, the average rate of sink is approximately 40 fpm less than if the aircraft were flying at $V_{L/D_{\max}}$. Consequently, at the end of the acceleration phase the aircraft is approximately six feet higher and at $V_{L/D_{\max}}$ will glide an additional 63 feet. The net loss in distance towards the runway is thus on the order of 17 feet, a negligible amount. Furthermore, Hale⁴ shows that, for other than the no wind condition, flying the aircraft slower results in a more optimal glide. The slightly slower velocity during the acceleration partially compensates for the loss in distance towards the runway.

From these results it is clear that the simplified model adequately represents the physics of the problem at least to a first approximation.

Comparison

In Ref. 1 Eckalbar states “If you depart straight out in a 285 hp Bonanza climbing at 96 kts, you will be about 11,000 feet from your brake release point when you reach 1,000 feet agl”. Eckalbar’s recommended procedure¹ assumes a steady climb at $V_{R/C_{\max}}$. For these conditions the turn radius at $V_{\text{turning}} = 1.3V_{\text{stall (clean)}}/\cos \phi = 123.5$ mph and a 35 degree bank angle is approximately 981 feet. Eckalbar gives the altitude loss during the turn as 792 feet. Thus, at the completion of the 270/90° turn the aircraft is 9,038 feet from the brake release point at an altitude of 208 feet. At $V_{L/D_{\max}}$ from an altitude of 208 feet the aircraft glides 2197 feet before contacting the ground. Thus, to land on the end of the departure runway requires a runway length of 6841 feet from brake release, i.e., a runway nearly 7000 feet long.

In contrast, the present model using a teardrop flight path, climb out at $V_{\gamma_{\max}}$, and a $\phi = 45^\circ$ bank angle at a velocity of $V_{\text{turning}} = 1.05V_{\text{stall (clean)}}/\cos \phi = 107.7$ mph yields a required runway length of approximately 825 feet, a factor of more than *eight* less than the procedure recommended by Eckalbar¹. Using a 35° bank angle increases the required runway length to approximately 1450, feet which is still a factor of nearly *five* less.

Can the Pilot Execute This Maneuver?

Based on statistics obtained from accident investigations conducted by the National Transportation Safety Board (NTSB) (see, for example, Ref. 5) the FAA and most general aviation safety experts conclude that a low-level high bank angle turn is likely to result in a classic stall/spin accident with little chance of survival. Unfortunately, little attempt at validating the data base with respect to its *completeness* has been attempted. In fact, it is reasonable to conclude that the statistical accident/incident data base is incomplete. For example, if a turnback maneuver after engine failure is successfully completed or results in only minor damage, then generally *no report* is made to either the FAA or the NTSB. Furthermore, if a report is made, then it is likely that the report will stress the reason for the engine failure and *not* the maneuver that resulted in a successful on-airport landing. Consequently, the statistical data base is skewed towards failed attempts. Hence, conclusions drawn from analyses using these data bases are suspect at best.

Although the turnback maneuver is a high performance edge of the envelop maneuver, there is good evidence that a well-trained pilot is capable of successfully performing it. Jett, in the simulator study reported in Ref. 3, showed that with minimal training over 90% of pilots with more than 100 hours of flight time were able to successfully complete the maneuver using a 45° bank angle and a velocity of approximately $1.05V_{\text{turning}}$. Furthermore, the turnback maneuver is a standard required maneuver for the glider rating. An applicant for a glider rating must demonstrate, starting from an altitude of 200 feet agl, the ability to turn back to the departure runway when the tow rope breaks before qualifying for the rating. An unpowered single engine aircraft is simply a glider with a lower L/D ratio than a sailplane. Fundamentally the only difference between a sailplane and an unpowered single engine aircraft is the critical altitude required to successfully complete the maneuver.

Conclusions

A simplified model of the turnback maneuver after engine failure during the take-off climb segment has been developed. The model shows that optimum conditions for returning to the departure runway result from climbing at $V_{\gamma_{\max}}$, executing a gliding turn through a 190–220° heading change, using a 45° bank angle at 5% above the stall velocity in the turn using a teardrop shaped flight path.

References

1. Eckalbar, John C., “The Optimum Turn”, Newsletter of the American Bonanza Society, Vol. 92, No. 8, pp 3037-3038, 3044, 1992.
2. Eckalbar, John C., *Flying The Beech Bonanza*, McCormick-Armstrong Publishing, Wichita, KS, 1986.
3. Jett, Brent W., “The Feasibility of Turnback from a Low Altitude Engine Failure During the Takeoff Climb-out Phase”, AIAA Paper 82-0406, presented at the 20th Aerospace Sciences Meeting, 11-14 January 1982, Orlando, FL.
4. Hale, Francis J., *Introduction to Aircraft Performance, Selection, and Design*, John Wiley & Son, New York, 1984.
5. *General Aviation Accident Analysis Book*, AOPA Air Safety Foundation, Frederick, MD, 1991.